









物料名	エフピー株式会社新築工事					色	原板	型材
							エフピー色	

MN-1	M-2	MN-3	MN-4	MN-5	MD-2	L15	M4
							

外観図



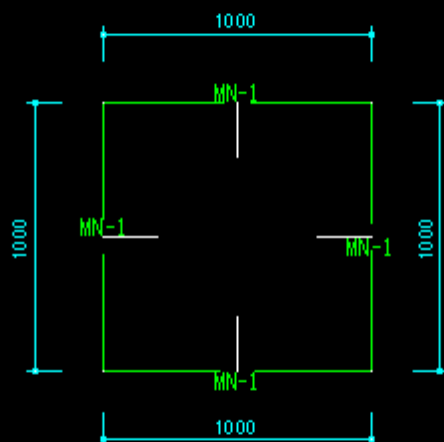







縮尺 1/20

パネル No.	(W)	(H)	板目	向き	枚数	m ²
L-001	1000	1000	←		1	1

エフピー株式会社

総枚数
総m²

物件名	エフピー株式会社新築工事				色	原 紙	習 紙
						エフピー色	

MN-1	M-2	MN-3	MN-4	MN-6	MD-2	L16	M4
							

外
観
図

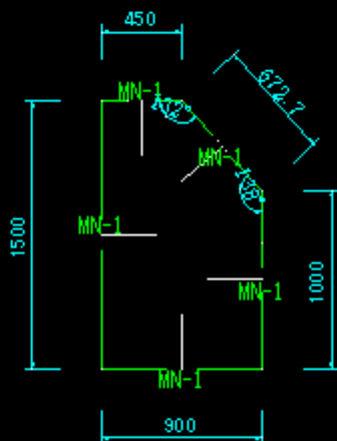

縮尺 1/30









パネル No.	(W)	(H)	板目	積層	枚数	m ²
1A-003	900	1500	←		1	1.24

エフピー株式会社

総枚数

総m²

構件名	エフピー株式会社新築工事	色	黒板	素材
			エフピー色	

MN-1	M-2	MN-3	MN-4	MN-5	MD-2	L16	M4
							

外観図

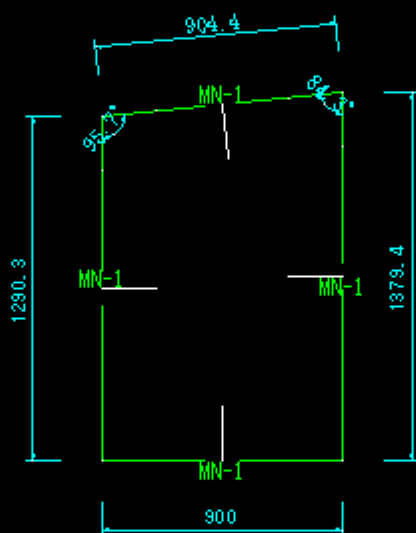

縮尺 1/20

パネル No.	(W)	(H)	板目	向き	枚数	m ²
1A-004	900	1379.4	←		1	1.2

エフピー株式会社

総枚数
総m²